

# Hydrawise-Ready Controllers

*INSTALLATION GUIDE FOR THE FOLLOWING HUNTER CONTROLLERS:*

**HC**

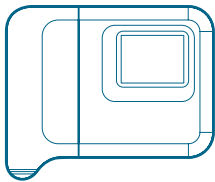

**HPC**

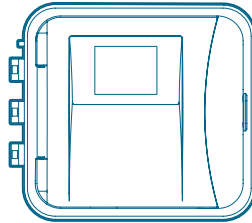

**Pro-HC**

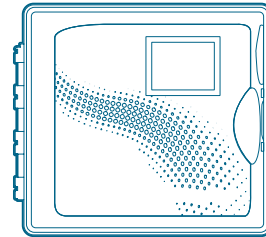

**The Most Complete**  
Wi-Fi Irrigation Control System

**Hunter**<sup>®</sup>



---

# Table of Contents

---

- 3 Thank You for Purchasing a Hydrawise-Ready Controller**
- 7 Mount Your Controller**
  - 7 HC Controller
  - 9 HPC or Pro-HC Controllers
- 11 Connect Power to Your Controller**
  - 11 HC Controller
  - 13 Indoor Pro-HC Controller
  - 15 Outdoor HPC and Pro-HC Controllers
- 18 Retrofit Your Pro-C® Controller**
  - 18 With the HPC-FP Kit
- 21 Home Screen Navigation**
  - 24 Using the Connection Wizard
- 28 Notices**
  - 28 U.S. FCC Statement
  - 28 Innovation, Science, and Economic Development Canada (ISED) Compliance Notice
  - 28 Déclaration d'Industrie Canada
  - 28 Certificate of Conformity to European Directives
- 30 Notes**



Download the Hydrawise App from the Apple® App Store or Google Play™ Store, or log in on the Hydrawise.com website.



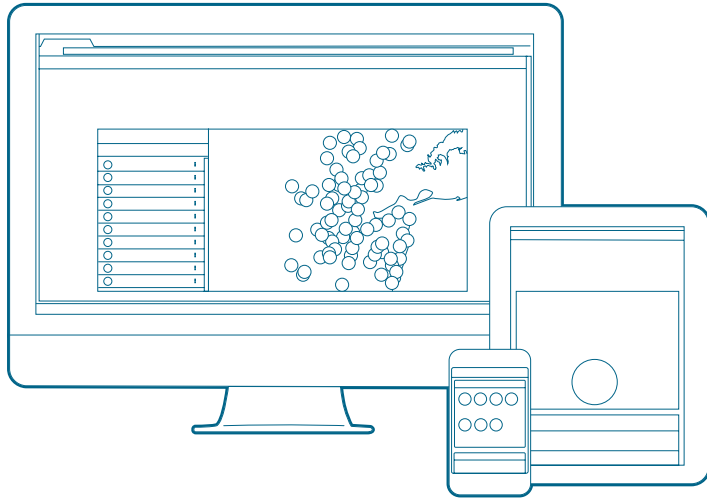

Your Hydrawise-ready controller can connect to the internet via your Wi-Fi router. Once connected, you can access and manage your irrigation system with your smartphone, tablet, or computer. Visit [hydrawise.com](https://www.hydrawise.com) to get started.

Need more helpful information on your product? Scan below to find tips on installation, controller programming, and more.



**Important:** A medium-to-high signal strength is preferred to maintain a stable connection between the controller and the router. In some cases, a Wi-Fi extender should be installed to increase the signal. Obstructions such as interior walls and landscaping can block the signal.



[hunter.help/hydrawise](https://hunter.help/hydrawise)



Visit [hunter.help/wifispecs](https://hunter.help/wifispecs) to ensure your Wi-Fi network meets the requirements of your Hunter Hydrawise-ready controller.

### **DE Vielen Dank, dass Sie sich für das Hydrawise Ready Steuergerät entschieden haben**

Ihr Hydrawise-fähiges Steuergerät kann über Ihren WLAN-Router eine Verbindung ins Internet herstellen. Sobald die Verbindung hergestellt ist, können Sie per Smartphone, Tablet oder Computer auf Ihr Bewässerungssystem zugreifen und es verwalten. Besuchen Sie [hydrawise.com](http://hydrawise.com), um anzufangen.

Wünschen Sie weitere hilfreiche Informationen zu Ihrem Produkt? Scannen Sie den Code für hilfreiche Tipps zur Installation, Programmierung des Steuergeräts sowie weitere Informationen.

[hunter.info/hydrawiseTECH](http://hunter.info/hydrawiseTECH)

**! Wichtig:** Mittlere bis hohe Signalstärke ist notwendig, um eine stabile Verbindung zwischen Steuergerät und Router aufrechtzuerhalten. In manchen Fällen muss ein WLAN-Verstärker installiert werden, um den Empfang zu verbessern. Hindernisse wie Innenwände oder Objekte in der Außenanlage können das Signal blockieren.

### **ES Gracias por comprar un programador de riego compatible con Hydrawise**

Su programador compatible con Hydrawise puede conectarse a Internet a través de su router Wi-Fi. Una vez conectado, podrá acceder y gestionar su sistema de riego con su smartphone, tableta u ordenador. Visite [hydrawise.com](http://hydrawise.com) para comenzar.

¿Necesita más información sobre el producto? Escanee a continuación para encontrar consejos sobre instalación, configuración de programadores, etc.

[hunter.info/hydrawiseTECH](http://hunter.info/hydrawiseTECH)

**! Importante:** Es préférable una intensidad de señal media-alta para mantener una conexión estable entre el programador y el router. En algunos casos, se debe instalar un amplificador Wi-Fi para aumentar la señal. Obstáculos como paredes interiores y jardines pueden bloquear la señal.

### **FR Merci d'avoir acheté un programmeur compatible Hydrawise**

Votre programmeur compatible Hydrawise peut se connecter à Internet via votre routeur Wi-Fi. Une fois connecté, vous pouvez accéder à votre système d'arrosage et le gérer à l'aide de votre smartphone, tablette ou ordinateur. Rendez-vous sur [hydrawise.com](http://hydrawise.com) pour commencer.

Vous avez besoin d'informations supplémentaires sur votre produit ? Scannez ci-dessous pour obtenir des conseils sur l'installation, la programmation, etc.

[hunter.info/hydrawiseTECH](http://hunter.info/hydrawiseTECH)

**! Important :** Il est préférable d'avoir une puissance de signal moyenne à élevée pour maintenir une connexion stable entre le programmeur et le routeur. Dans certains cas, une rallonge Wi-Fi doit être installée pour augmenter le signal. Les obstacles tels que les murs intérieurs et les aménagements paysagers peuvent bloquer le signal.

**IT Grazie per aver acquistato un programmatore Hydrowise-Ready**

Il programmatore Hydrowise-Ready può connettersi a Internet tramite il router Wi-Fi. Una volta connesso, è possibile accedere e gestire il sistema di irrigazione tramite smartphone, tablet o computer. Visita [hydrowise.com](http://hydrowise.com) per iniziare.

Servono maggiori informazioni sul prodotto? Scansiona qui sotto per trovare suggerimenti sull'installazione, la programmazione del programmatore e altro ancora.

[hunter.info/hydrowiseTECH](http://hunter.info/hydrowiseTECH)

**! Importante:** È preferibile una potenza di segnale medio-alta per mantenere una connessione stabile tra il programmatore e il router. In alcuni casi, è necessario installare un ripetitore Wi-Fi per aumentare il segnale. Elementi come pareti interne o elementi dell'area verde possono rappresentare degli ostacoli e bloccare il segnale.

**PT Obrigado por adquirir um controlador de irrigação compatível com o Hydrowise**

Seu controlador compatível com Hydrowise pode se conectar à Internet por meio do roteador Wi-Fi. Uma vez conectado, você pode acessar e gerenciar seu sistema de irrigação com seu smartphone, tablet ou computador. Visite [hydrowise.com](http://hydrowise.com) para começar.

Deseja mais informações sobre seu produto? Digitalize abaixo para encontrar dicas sobre instalação, programação do controlador e mais.

[hunter.info/hydrowiseTECH](http://hunter.info/hydrowiseTECH)

[hunterindustries.com](http://hunterindustries.com)

**! Importante:** É preferível uma força de sinal média a alta para manter uma conexão estável entre o controlador e o roteador. Em alguns casos, um extensor de Wi-Fi deve ser instalado para aumentar o sinal. Obstruções como paredes interiores e paisagem podem bloquear o sinal.

**RU Благодарим вас за покупку контроллера с поддержкой системы Hydrowise!**

Контроллер с поддержкой Hydrowise можно подключить к интернету при помощи Wi-Fi-маршрутизатора. Установив соединение, вы сможете отслеживать и контролировать работу оросительной системы прямо со смартфона, планшета или компьютера. Посетите сайт [hydrowise.com](http://hydrowise.com), чтобы приступить к настройке.

Нужна более подробная информация о контроллере? Отсканируйте этот код, чтобы найти полезные советы по установке, программированию и другим вопросам.

[hunter.info/hydrowiseTECH](http://hunter.info/hydrowiseTECH)

**Внимание!** Для поддержания стабильной связи между контроллером и маршрутизатором последний должен обеспечивать сильный или как минимум средний сигнал. В некоторых случаях для повышения качества сигнала вам потребуется усилитель Wi-Fi. Сигнал могут блокировать препятствия, например внутренние стены или элементы ландшафта. Для поддержания стабильной связи между контроллером и маршрутизатором последний должен обеспечивать сильный или как минимум средний сигнал. В некоторых случаях для повышения качества сигнала вам потребуется усилитель Wi-Fi. Сигнал могут блокировать препятствия, например внутренние стены или элементы ландшафта.

## Thank You for Purchasing a Hydrawise-Ready Controller

---

### TR Hydrawise Kontrol Ünitesini Satın Aldığınız İçin Teşekkür Ederiz

Hydrawise kontrol üniteniz, Wi-Fi yönlendiriciniz üzerinden internete bağlanabilir. İnternete bağlandıktan sonra akıllı telefonunuz, tabletiniz veya bilgisayarınızla sulama sisteminize erişebilirsiniz ve onu yönetebilirsiniz. Başlamak için [hydrawise.com](http://hydrawise.com) adresini ziyaret edin.

Ürününüz hakkında daha fazla faydalı bilgiye mi ihtiyacınız var? Kurulum, kontrol ünitesinin programlanması ve çok daha fazlası hakkında ipuçlarına ulaşmak için aşağıyı inceleyin.

[hunter.info/hydrawiseTECH](http://hunter.info/hydrawiseTECH)

**! Önemli:** Kontrol ünitesi ve yönlendirici arasında sağlıklı bir bağlantı sağlamak için orta veya yüksek sinyal gücü önerilmektedir. Bazı durumlarda sinyal gücünü artırmak için Wi-Fi menzil genişletici kullanılmalıdır. Bina içi duvarlar ve peyzaj düzenlemesi gibi engeller sinyali engelleyebilir.

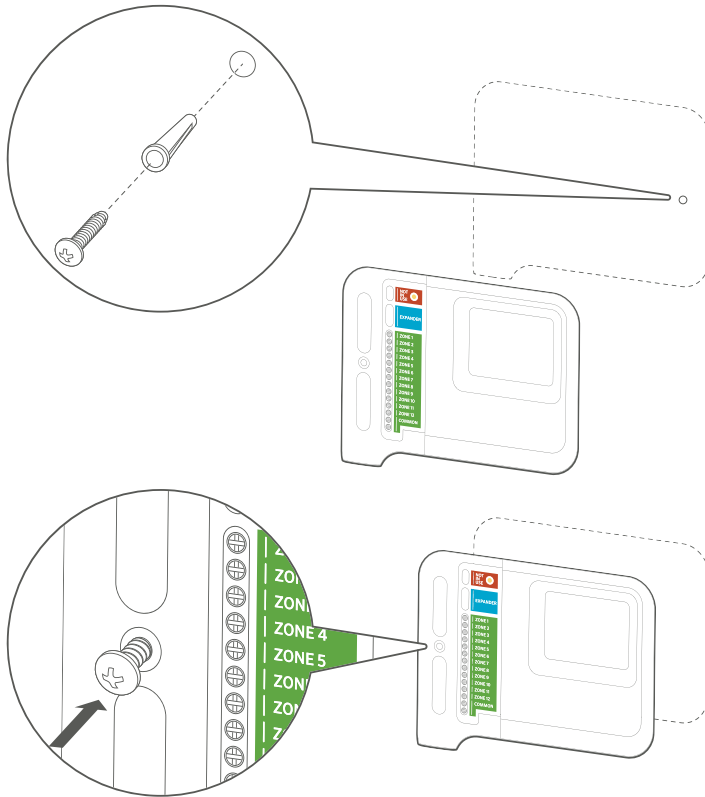

### HC Controller

1. Choose a suitable location with strong Wi-Fi coverage.
2. Using a  $\frac{3}{16}$ " drill bit, drill a hole and insert a plastic anchor.
3. Insert a screw into the anchor, leaving  $\frac{1}{8}$ " exposed.
4. Slide the controller case over the screwhead.
5. Mark a second mounting point, drill and fit the anchor, and fix the controller in place.

### DE HC-Steuergerät montieren

1. Wählen Sie einen Standort mit einer guten WLAN-Abdeckung aus.
2. Bohren Sie mit einem 5 mm Bohrer ein Loch und setzen einen Kunststoffdübel ein.
3. Drehen Sie eine Schraube in den Dübel, und lassen diese ca. 3 mm überstehen.
4. Schieben Sie das Gehäuse des Steuergeräts über den Schraubenkopf.
5. Markieren Sie den zweiten Montagepunkt, bohren ein Loch, setzen einen Kunststoffdübel ein und schrauben das Steuergerät fest.

### ES Monte su Programador HC

1. Elija una ubicación adecuada con una buena cobertura Wi-Fi.
2. Con una broca de  $\frac{3}{16}$ ", taladre un orificio e inserte un soporte de pared de plástico.
3. Inserte un tornillo en el soporte, dejando  $\frac{1}{8}$ " expuesto.
4. Coloque la caja del programador sobre la cabeza del tornillo.
5. Marque un segundo punto de montaje, perforo y ajuste el soporte y fije el programador en su lugar.

### **FR Fixez votre programmeur HC**

1. Choisissez un emplacement approprié avec une bonne couverture Wi-Fi.
2. À l'aide d'un foret de diamètre  $\frac{3}{16}$ " (5 mm), percez un trou et insérez la cheville en plastique.
3. Insérez la vis dans la cheville en laissant exposés  $\frac{1}{8}$ " (3 mm) de filetage.
4. Faites glisser le boîtier du programmeur sur la tête de la vis.
5. Marquez le deuxième point de fixation, percez le trou, insérez la cheville et fixez le programmeur en place.

### **IT Montaggio del programmatore HC**

1. Scegliere un luogo idoneo con una buona copertura Wi-Fi.
2. Utilizzando una punta da trapano da 5 mm, praticare un foro e inserire un tassello in plastica.
3. Inserire una vite nel tassello, lasciandola svitata per 3 mm.
4. Fate scorrere l'involucro del programmatore sulla testa della vite.
5. Contrassegnare il secondo punto di montaggio, forare con il trapano, inserire il tassello e posizionare il programmatore.

### **PT Monte seu controlador HC**

1. Escolha um local adequado com forte cobertura da rede Wi-Fi.
2. Usando uma broca de  $\frac{3}{16}$ ", faça um furo e insira uma bucha plástica.
3. Insira um parafuso na bucha, deixando  $\frac{1}{8}$ " de polegada exposto.
4. Deslize o estojo do controlador na cabeça do parafuso.
5. Marque um segundo ponto de montagem, faça o furo e coloque a bucha, e fixe o controlador no lugar.

### **RU Как установить контроллер HC**

1. Выберите подходящее место установки с надежным покрытием сети Wi-Fi.
2. Просверлите отверстие сверлом  $\frac{3}{16}$ " (5 мм) и вставьте в него пластиковый дюбель.
3. Вкрутите винт так, чтобы он выступал на  $\frac{1}{8}$ " (чуть больше 3 мм) от крепежной поверхности.
4. Навесьте корпус контроллера на головку винта.
5. Отметьте вторую точку крепления, просверлите отверстие, вставьте дюбель, вкрутите винт и закрепите контроллер на месте.

### **TR HC Kontrol Ünitenizin Montajı**

1. Wi-Fi bağlantısının güçlü olduğu uygun bir konum seçin.
2.  $\frac{3}{16}$ " matkap ucu kullanarak bir delik açın ve plastik dübeli deliğe sokun.
3. Vidayı  $\frac{1}{8}$ " açıkta bırakarak dübelin içine yerleştirin.
4. Kontrol ünitesi kutusunu vidanın başına kaydırın.
5. İkinci montaj noktasını işaretleyip delin, dübeli takın ve kontrol ünitesini yerine sabitleyin.



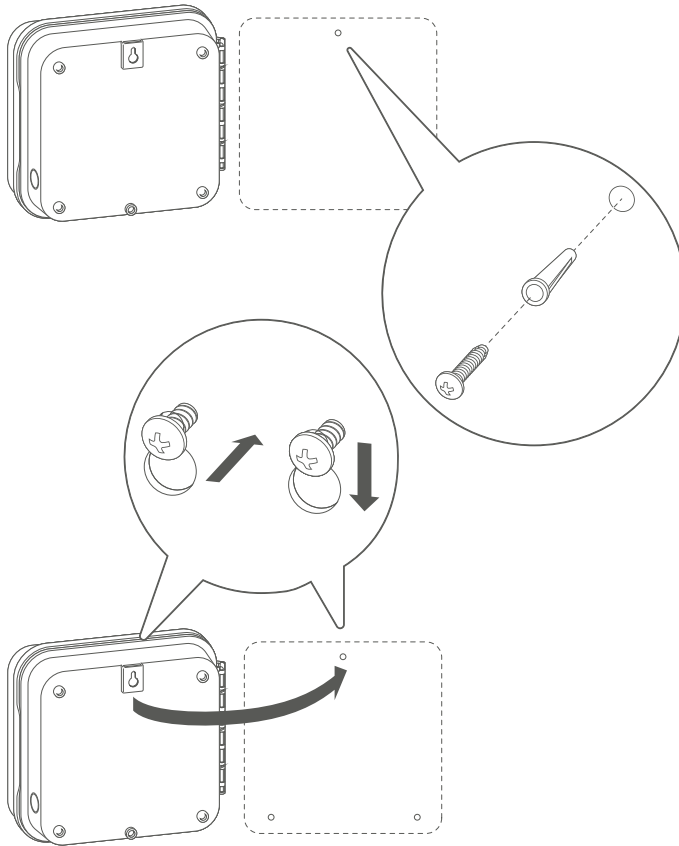

### HPC or Pro-HC Controllers

1. Choose a suitable location with strong Wi-Fi coverage.
2. Using a  $\frac{3}{16}$ " drill bit, drill a hole and insert a plastic anchor.
3. Insert a screw into the anchor, leaving  $\frac{1}{8}$ " exposed.
4. Slide the controller case over the screw head.
5. Mark a second mounting point, drill and fit the anchor, and fix the controller in place.

### DE HPC oder Pro-HC Steuergerät

1. Wählen Sie einen Standort mit einer guten WLAN-Abdeckung aus.
2. Bohren Sie mit einem 5 mm Bohrer ein Loch und setzen einen Kunststoffdübel ein.
3. Drehen Sie eine Schraube in den Dübel, und lassen diese ca. 3 mm überstehen.
4. Schieben Sie das Gehäuse des Steuergeräts über den Schraubenkopf.
5. Markieren Sie den zweiten Montagepunkt, bohren Sie ein Loch, setzen Sie einen Kunststoffdübel ein und schrauben Sie das Steuergerät fest.

### ES Programador HPC o Pro-HC

1. Elija una ubicación adecuada con una buena cobertura Wi-Fi.
2. Con una broca de  $\frac{3}{16}$ ", taladre un orificio e inserte un soporte de pared de plástico.
3. Inserte un tornillo en el soporte, dejando  $\frac{1}{8}$ " expuesto.
4. Coloque la caja del programador sobre la cabeza del tornillo.
5. Marque un segundo punto de montaje, perfore y ajuste el soporte y fije el programador en su lugar.

### FR Programmeur HPC ou Pro-HC

1. Choisissez un emplacement approprié avec une bonne couverture Wi-Fi.
2. À l'aide d'un foret de diamètre  $\frac{3}{16}$ " (5 mm), percez un trou et insérez la cheville en plastique.
3. Insérez la vis dans la cheville en laissant exposés  $\frac{1}{8}$ " (3 mm) de filetage.
4. Faites glisser le boîtier du programmeur sur la tête de la vis.
5. Marquez le deuxième point de fixation, percez le trou, insérez la cheville et fixez le programmeur en place.

### IT Programmatore HPC o Pro-HC

1. Scegliere un luogo idoneo con una buona copertura Wi-Fi.
2. Utilizzando un trapano con punta da 5 mm, praticare un foro e inserire un tassello in plastica.
3. Inserire una vite nel tassello, lasciandola svitata per 3 mm.
4. Fate scorrere l'involucro del programmatore sulla testa della vite.
5. Contrassegnare il secondo punto di montaggio, forare con il trapano, inserire il tassello e posizionare il programmatore.

### PT Controladores HPC ou Pro-HC

1. Escolha um local adequado com forte cobertura da rede Wi-Fi.
2. Usando uma broca de  $\frac{3}{16}$ ", faça um furo e insira uma bucha plástica.
3. Insira um parafuso na bucha, deixando  $\frac{1}{8}$ " de polegada exposto.
4. Deslize o estojo do controlador na cabeça do parafuso.
5. Marque um segundo ponto de apoio, perfure e encaixe a âncora e prenda o controlador no lugar.

### RU Контроллеры HPC и Pro-HC

1. Выберите подходящее место установки с надежным покрытием сети Wi-Fi.
2. Просверлите отверстие сверлом  $\frac{3}{16}$ " (5 мм) и вставьте в него пластиковый дюбель.
3. Вкрутите винт так, чтобы он выступал на  $\frac{1}{8}$ " (чуть больше 3 мм) от крепежной поверхности.
4. Навесьте корпус контроллера на головку винта.
5. Отметьте вторую точку крепления, просверлите отверстие, вставьте дюбель, вкрутите винт и закрепите контроллер на месте.

### TR HPC veya Pro-HC Kontrol Üniteleri

1. Wi-Fi bağlantısının güçlü olduğu uygun bir konum seçin.
2.  $\frac{3}{16}$ " matkap ucu kullanarak bir delik açın ve plastik dübeli deliğe sokun.
3. Vidayı  $\frac{1}{8}$ " açıkta bırakarak dübelin içine yerleştirin.
4. Kontrol ünitesi kutusunu vidanın başına kaydırın.
5. İkinci montaj noktasını işaretleyip delin, dübeli takın ve kontrol ünitesini yerine sabitleyin.

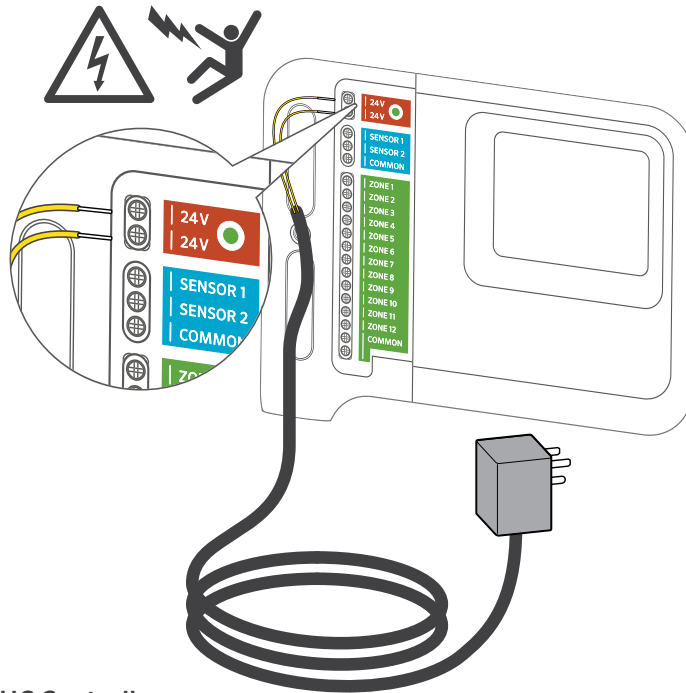

### HC Controller

1. Do not plug the transformer into the power source until controller is mounted and all wiring has been connected.
2. Remove the blue cover to the junction box.
3. Route the transformer cable through the hole on the bottom of the controller, connect one yellow wire to each of the terminals marked 24 VAC, and replace the junction box cover.



#### Important:

The HC Controller is designed for indoor use only. Do not cut the cord.

### DE HC-Steuergerät mit Stromquelle verbinden

1. Verbinden Sie den Transformator nicht mit der Stromquelle, bis das Steuergerät montiert und alle Kabel verbunden sind.
2. Entfernen Sie die blaue Abdeckung der Anschlussdose.
3. Führen Sie das Trafokabel durch die Öffnung unten am Steuergerät und schließen die gelben Adern jeweils an eine mit 24 VAC gekennzeichnete Klemme an. Bringen Sie die Abdeckung der Anschlussdose wieder an.

**! Wichtig:** Das HC-Steuergerät kann nur im Innenbereich eingesetzt werden. Schneiden Sie das Kabel nicht ab.

### ES Conecte la corriente a su programador HC

1. No conecte el transformador a la toma de corriente hasta que el programador esté montado y haya conectado todos los cables.
2. Abra la carátula para exponer el armario del programador.
3. Introduzca el cable del transformador por el orificio ubicado en el área inferior izquierda del programador, conecte un cable amarillo a cada uno de los tornillos marcados como 24 VAC y conecte el cable verde al tornillo marcado como GND.

**! Importante:** El programador HC está diseñado solo para uso en interiores. No corte el cable.

### **FR Branchez votre programmeur HC à l'alimentation**

1. Ne branchez pas le transformateur à la source d'alimentation tant que le programmeur n'est pas fixé et que tous les branchements ne sont pas effectués.
2. Retirez le couvercle bleu de la boîte de jonction.
3. Acheminez le câble du transformateur par le trou situé en bas du programmeur, connectez un fil jaune à chacune des bornes portant la mention 24 Vca et replacez le couvercle de la boîte de jonction.

**! Important:** Le programmeur HC est uniquement conçu pour être utilisé en intérieur. Ne coupez pas le câble.

### **IT Collegamento del programmatore HC all'alimentazione**

1. Non collegate il trasformatore alla presa di corrente finché il programmatore non è montato e tutti i cavi sono stati collegati.
2. Rimuovere il coperchio blu dalla scatola di derivazione.
3. Inserire il cavo del trasformatore nel foro collocato nella parte inferiore del programmatore, collegare un cavo giallo a ciascuno dei terminali contrassegnati con 24 V CA e riposizionare il coperchio della scatola di derivazione.

**! Importante:** Il Programmatore HC è progettato solo per l'uso interno. Non tagliare il cavo.

### **PT Conecte o controlador HC à alimentação**

1. Não conecte o transformador à fonte de alimentação até que o controlador esteja montado e toda a fiação esteja conectada.
2. Remova a tampa azul para a caixa de passagem.

3. Passe o cabo do transformador pelo buraco na parte inferior do controlador, conecte um fio amarelo a cada um dos terminais marcados com 24 VCA e recoloque a tampa da caixa de passagem.

**! Importante:** O Controlador HC foi projetado apenas para uso interno. Não corte o fio.

### **RU Подключение питания к контроллеру HC**

1. Не подключайте трансформатор к источнику питания до окончания процесса установки контроллера и подключения всех проводов.
2. Снимите синюю крышку с распределительной коробки.
3. Проведите кабель трансформатора через отверстие в нижней части контроллера. Подсоедините по одному желтому проводу к каждой клемме с маркировкой 24 VAC («~24 В») и заново установите крышку распределительной коробки.

**! Важно:** Контроллер HC предусмотрен только для использования в помещении. Не обрезайте его шнур.

### **TR HC Kontrol Ünitenize Elektriksel Güç Bağlantısı**

1. Kontrol ünitesi monte edilip tüm kablolar bağlanmadan transformatörü güç kaynağına takmayın.
2. Bağlantı kutusunun mavi kapağını çıkarın.
3. Transformatör kablosunu kontrol ünitesinin altındaki delikten geçirin, 24 VAC işaretli terminallerin her birine birer adet sarı kablo bağlayın ve bağlantı kutusunun kapağını tekrar yerine takın.

**! Önemli:** HC kontrol ünitesi yalnızca iç mekanda kullanılmak üzere tasarlanmıştır. Kabloyu kesmeyin.

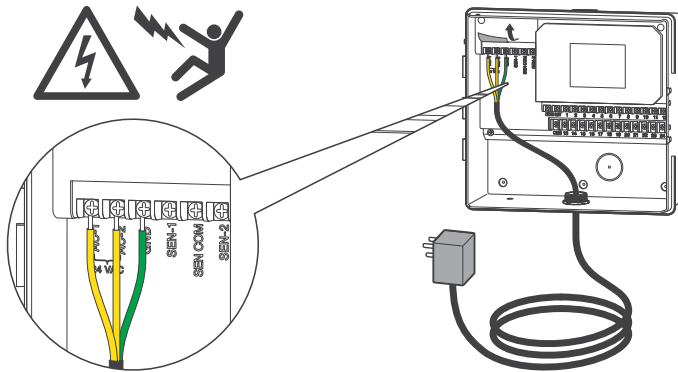

### Indoor Pro-HC Controller

1. Do not plug the transformer into the power source until controller is mounted and all wiring has been connected.
2. Open the facepack to expose the controller cabinet.
3. Route the transformer cable through the hole on the bottom left of the controller, connect one yellow wire to each of the screws marked 24 VAC, and wire the green wire to the screw marked GND.
4. The HC Controller is designed for indoor use only. Do not cut the cord.

### DE Pro-HC Steuergerät für den Innenbereich mit Stromquelle verbinden

1. Verbinden Sie den Transformator nicht mit der Stromquelle, bis das Steuergerät montiert und alle Kabel verbunden sind.
2. Öffnen Sie die Bedienfront, um an das Gehäuse des Steuergeräts zu gelangen.
3. Führen Sie das Trafokabel durch die Öffnung unten links am Steuergerät und schließen die gelben Adern jeweils an eine mit 24 VAC gekennzeichnete Klemme an. Schließen Sie die grüne Ader an die GND-Klemme an.
4. Schneiden Sie das Kabel nicht ab.

### ES Conecte la alimentación a su Programador Pro-HC para interiores

1. No conecte el transformador a la toma de corriente hasta que el programador esté montado y haya conectado todos los cables.
2. Abra la carátula para exponer el armario del programador.
3. Introduzca el cable del transformador por el orificio ubicado en el área inferior izquierda del programador, conecte un cable amarillo a cada uno de los tornillos marcados como 24 VAC y conecte el cable verde al tornillo marcado como GND.
4. El programador HC está diseñado solo para uso en interiores. No corte el cable.

### **FR Connectez l'alimentation à votre programmeur Pro-HC d'intérieur**

1. Ne branchez pas le transformateur à la source d'alimentation tant que le programmeur n'est pas fixé et que tous les branchements ne sont pas effectués.
2. Ouvrez la façade pour exposer le boîtier du programmeur.
3. Acheminez le câble du transformateur par le trou situé en bas à gauche du programmeur, connectez un fil jaune à chacune des vis portant la mention 24 Vca et raccordez le fil vert à la vis GND.
4. Ne coupez pas le câble.

### **IT Collegare l'alimentazione al programmatore Pro-HC**

1. Non collegate il trasformatore alla presa di corrente finché il programmatore non è montato e tutti i cavi sono stati collegati.
2. Aprire il frontalino per accedere all'interno del programmatore.
3. Far passare il cavo del trasformatore nel foro collocato sul lato inferiore sinistro del programmatore, collegare un cavo giallo a ciascuna delle viti contrassegnate con 24 V CA e il cavo verde alla vite contrassegnata con GND.
4. Non tagliate il cavo.

### **PT Conecte energia ao seu controlador Pro-HC interno**

1. Não conecte o transformador à fonte de alimentação até que o controlador esteja montado e toda a fiação esteja conectada.
2. Abra a painel frontal para expor o gabinete do controlador.

3. Passe o cabo do transformador pelo furo na parte inferior esquerda do controlador, conecte um fio amarelo a cada parafuso marcado com 24 VCA e o fio verde ao parafuso marcado com GND.
4. Não corte o fio.

### **RU Как подключить контроллер Pro-HC к источнику питания**

1. Не подключайте трансформатор к источнику питания до окончания процесса установки контроллера и подключения всех проводов.
2. Откройте внешнюю панель управления, под которой расположен корпус контроллера.
3. Проведите кабель трансформатора через отверстие в левой нижней части контроллера. Подсоедините по одному желтому проводу к каждому винту с маркировкой 24 VAC («~24 В»), а зеленый провод подключите к винту с отметкой GND.
4. Не обрезайте шнур.

### **TR İç Mekan Pro-HC Kontrol Ünitenize Güç Bağlantısı**

1. Kontrol ünitesi monte edilip tüm kablolar bağlanmadan transformatörü güç kaynağına takmayın.
2. Kontrol ünitesi kabinini görmek için ön paneli açın.
3. Transformatör kablosunu kontrol ünitesinin sol alt tarafındaki delikten geçirin, 24 VAC işaretli vidaların her birine birer adet sarı kablo bağlayın ve yeşil kabloyu GND işaretli vidaya bağlayın.
4. Kabloyu kesmeyin.

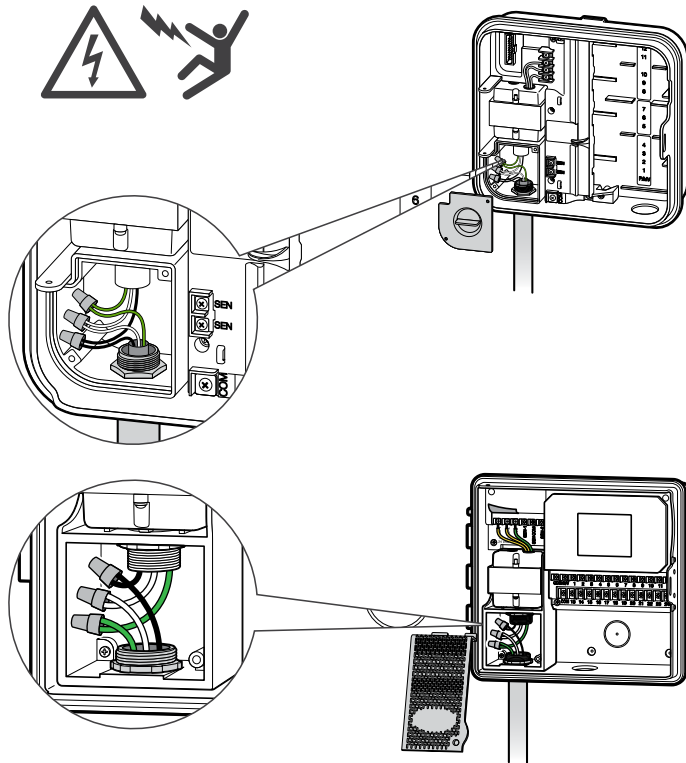

### Outdoor HPC and Pro-HC Controllers



#### Important:

Outdoor HPC and Pro-HC Controllers must be installed by an authorized service technician.

1. Do not plug the transformer into the power source until controller is mounted and all wiring has been connected.
2. Remove the junction box cover, route the cable through the hole on the bottom left of the controller, and attach the cable using the adapter and nut inside the enclosure.
3. Connect the cable wires to the transformer wires in the junction box and replace the junction box cover.

### DE HPC und Pro-HC Steuergerät für den Außenbereich mit Stromquelle verbinden

**! Wichtig:** HPC und Pro-HC Steuergeräte für den Außenbereich müssen von einem autorisierten Techniker installiert werden.

1. Verbinden Sie den Transformator nicht mit der Stromquelle, bis das Steuergerät montiert und alle Kabel verbunden sind.
2. Entfernen Sie den Deckel der Anschlussdose, führen das Kabel durch die Öffnung unten links am Steuergerät und sichern das Kabel mit dem Adapter/Mutter im Gehäuse.
3. Verbinden Sie in der Anschlussdose Kabel- und Trafoadern und bringen die Abdeckung der Anschlussdose wieder an.

### ES Conecte la Alimentación a sus Programadores HPC y Pro-HC para exteriores

**! Importante:** Los Programadores HPC y Pro-HC para exteriores deben ser instalados por un técnico de servicio autorizado.

1. No conecte el transformador a la toma de corriente hasta que el programador esté montado y haya conectado todos los cables.
2. Retire la tapa de la caja de conexiones, introduzca el cable por el orificio en el área inferior izquierda del programador y conecte el cable usando el adaptador y la tuerca situados en el interior de la caja.
3. Conecte los cables a las conexiones del transformador en la caja de conexiones y coloque nuevamente la tapa de la caja.

### FR Connectez l'alimentation à vos programmeurs HPC et Pro-HC extérieurs

**! Important :** Les programmeurs HPC et Pro-HC extérieurs doivent être installés par un technicien agréé.

1. Ne branchez pas le transformateur à la source d'alimentation tant que le programmeur n'est pas fixé et que tous les branchements ne sont pas effectués.
2. Retirez le couvercle de la boîte de jonction, acheminez le câble par le trou situé en bas à gauche du programmeur, et fixez le câble à l'aide de l'adaptateur et de l'écrou à l'intérieur du boîtier.
3. Raccordez les câbles au transformateur dans la boîte de jonction et remplacez le couvercle de la boîte de jonction.

### IT Collegare l'alimentazione ai programmatori HPC e Pro-HC

**! Importante:** I programmatori HPC e Pro-HC devono essere installati da un tecnico specializzato.

1. Non collegate il trasformatore alla presa di corrente finché il programmatore non è montato e tutti i cavi sono stati collegati.
2. Rimuovere il coperchio della scatola di derivazione, instradare il cavo attraverso il foro collocato sulla parte inferiore sinistra del programmatore, quindi collegare il cavo utilizzando l'adattatore o i connettori all'interno dell'involucro.
3. Collegare i cavi ai fili del trasformatore nella scatola di derivazione, quindi riposizionare il coperchio della scatola di derivazione.

### PT Conecte energia ao seu HPC externo e controladores Pro-HC

**! Importante:** Controladores externos HPC e Pro-HC devem ser instalados por um técnico autorizado.

1. Não conecte o transformador à fonte de alimentação até que o controlador esteja montado e toda a fiação esteja conectada.
2. Remova a tampa da caixa de passagem, passe o cabo pelo buraco na parte inferior esquerda do controlador e fixe o cabo usando o adaptador e a porca dentro do invólucro.
3. Conecte os fios do cabo aos fios do transformador na caixa de passagem e substitua a tampa da caixa de passagem.



## **RU Как подключить к источнику питания контроллеры НРС и Pro-НС для наружного монтажа**

**! Важно:** Установкой контроллеров НРС и Pro-С для наружного монтажа должен заниматься сертифицированный специалист по техническом обслуживанию.

1. Не подключайте трансформатор к источнику питания до окончания процесса установки контроллера и подключения всех проводов.
2. Снимите крышку распределительной коробки. Проведите кабель через отверстие в левой нижней части контроллера и закрепите его при помощи адаптера и гайки, расположенных внутри корпуса.
3. Подсоедините провода кабеля к проводам трансформатора в распределительной коробке, после чего установите ее крышку на место.

## **TR Dış Mekan НРС ve Pro-НС Kontrol Ünitelerinize Güç Bağlantısı**

**! Önemli:** Dış mekan НРС ve Pro-НС Kontrol Üniteleri, yetkili bir servis teknisyeni tarafından kurulmalıdır.

1. Kontrol ünitesi monte edilip tüm kablolar bağlanmadan transformatörü güç kaynağına takmayın.
2. Bağlantı kutusunun kapağını çıkarın, kabloyu kontrol ünitesinin sol alt tarafındaki delikten geçirin ve adaptör ve somun kullanarak kabloyu muhafazanın içine takın.
3. Kabloları bağlantı kutusundaki transformatör kablolarına bağlayın ve bağlantı kutusunun kapağını tekrar yerine takın.

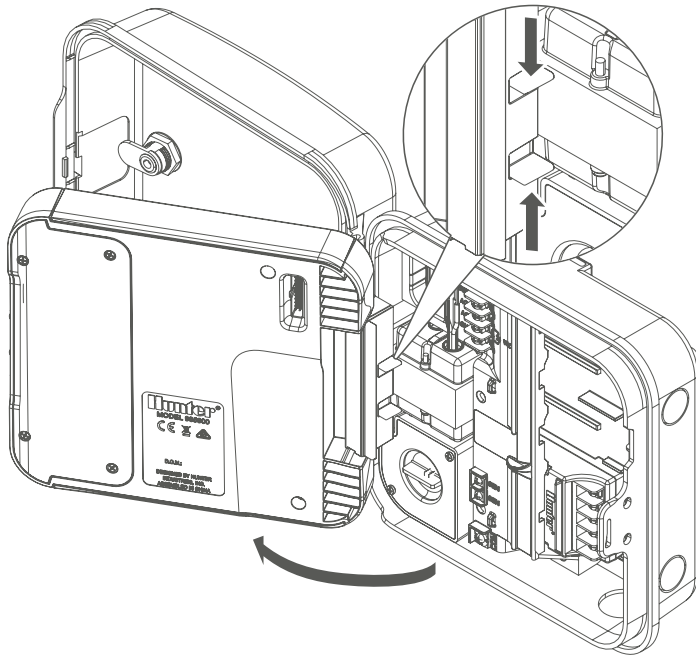

### With the HPC-FP Kit



#### Important:

Ensure you have a strong Wi-Fi signal. A signal strength of two or three bars is recommended. Wi-Fi connectivity can also be tested on the HPC Controller (signal strength is shown when you select a wireless network).

1. Do not plug the transformer into the power source until the controller is mounted and all wiring has been connected.
2. Open the controller facepack to access the cabinet, detach the ribbon cable, release the hinge on the back of the Pro-C facepack, and remove the facepack.
3. Press the hinges on the side of the HPC-FP facepack, insert the pins into the controller cabinet, reconnect the ribbon cable to the new facepack, and reconnect the power to the controller.

### DE Pro-C Steuergerät nachrüsten mit HPC-FP Kit

**! Wichtig:** Stellen Sie sicher, dass Sie ein starkes WLAN-Signal haben. Eine Signalstärke von zwei bis drei Balken ist erforderlich. Sie können die WLAN-Verbindung auch über das HPC direkt testen (Signalstärke wird angezeigt, wenn Sie ein drahtloses Netzwerk auswählen).

1. Verbinden Sie den Transformator nicht mit der Stromquelle, bis das Steuergerät montiert und alle Kabel verbunden sind.
2. Öffnen Sie die Bedienfront, um an das Gehäuse des Steuergeräts zu gelangen, trennen das Flachbandkabel, entriegeln das Scharnier auf der Rückseite der Pro-C Bedienfront und entfernen diese.

3. Drücken Sie auf die Scharniere seitlich an der HPC-FP Bedienfront, stecken die Stifte in das Gehäuse des Steuergeräts, verbinden das Flachbandkabel mit der neuen Bedienfront und verbinden das Steuergerät wieder mit der Stromquelle.

### ES Actualice su Programador Pro-C con el Kit HPC-FP

**! Importante:** Asegúrese de tener una señal Wi-Fi potente. Se recomienda una señal de dos o tres barras. También puede comprobar la conectividad Wi-Fi en el propio programador HC (se muestra la intensidad de señal cuando selecciona una red inalámbrica).

1. No conecte el transformador a la toma de corriente hasta que el programador esté montado y haya conectado todos los cables.
2. Abra la carátula para acceder a la caja, desconecte el cable plano, libere la bisagra en la parte posterior de la carátula del Pro-C y retire la carátula.
3. Presione las bisagras en el lado de la carátula del HPC-FP, inserte las clavijas en la caja del programador, reconecte el cable plano a la nueva carátula y reconecte la corriente al programador.

### FR Mettez à jour votre programmeur Pro-C avec le Kit HPC-FP

**! Important :** Assurez-vous d'avoir un signal Wi-Fi puissant. Nous vous recommandons une puissance de signal de deux ou trois barres. La connectivité Wi-Fi peut également être testée sur le programmeur HPC directement (la puissance du signal est indiquée lorsque vous sélectionnez un réseau sans fil).

1. Ne branchez pas le transformateur à la source d'alimentation tant que le programmeur n'est pas fixé et que tous les branchements ne sont pas effectués.
2. Ouvrez la façade du programmeur pour accéder au boîtier, décrochez le câble ruban, libérez la charnière à l'arrière de la façade du Pro-C et retirez la façade.
3. Appuyez sur les charnières situées sur le côté de la façade HPC-FP, insérez les broches dans le boîtier du programmeur, rebranchez le câble ruban à la nouvelle façade et rebranchez le programmeur à l'alimentation.

### IT Aggiornamento di Pro-C con il kit HPC-FP

**! Importante:** Assicurarsi di avere un segnale Wi-Fi forte. Si consiglia di utilizzare un segnale con potenza di due o tre barrette. La copertura Wi-Fi può essere verificata anche sul programmatore HPC (la potenza del segnale viene mostrata quando si seleziona una rete wireless).

1. Non collegare il trasformatore alla presa di corrente finché il programmatore non è montato e tutti i cavi sono stati collegati.
2. Aprire il frontalino del programmatore per accedere all'interno, staccare il cavo a nastro, rilasciare il cardini dal retro del frontalino Pro-C, quindi rimuovere il frontalino.
3. Premere i cardini sul lato del frontalino di HPC-FP, inserire i perni nell'armadetto del programmatore, ricollegare il cavo a nastro al nuovo frontalino e riattivare l'alimentazione del programmatore.

### PT Recupere seu controlador Pro-C com o Kit HPC-FP

**! Importante:** Certifique-se de ter um sinal Wi-Fi forte. É recomendável que a força do sinal seja de duas ou três barras. A conectividade Wi-Fi também pode ser testada no controlador HPC (a força do sinal é mostrada quando você seleciona uma rede sem fio).

1. Não conecte o transformador à fonte de energia até que o controlador esteja montado e toda a fiação esteja conectada.
2. Abra o painel frontal do controlador para acessar o gabinete, desconecte o cabo fita, solte a dobradiça na parte traseira da face frontal do Pro-C e remova o painel frontal.
3. Pressione as dobradiças na lateral do painel frontal do HPC-FP, insira os pinos no gabinete do controlador, reconecte o cabo de fita ao novo painel frontal e reconecte a alimentação ao controlador.

### RU Модернизация контроллера Pro-C с помощью комплекта HPC-FP

**! Важно:** Убедитесь, что ваша сеть обеспечивает надежный сигнал Wi-Fi. Рекомендуемый уровень сигнала — два-три столбика. Качество сигнала Wi-Fi также можно протестировать непосредственно на контроллере HPC (оно отображается при выборе беспроводной сети).

1. Не подключайте трансформатор к источнику питания до окончания процесса установки контроллера и подсоединения всех проводов.
2. Откройте внешнюю панель управления, за которой расположен корпус контроллера. Отсоедините шлейф, откройте петлю с тыльной стороны панели управления Pro-C и снимите панель.

3. Совместите выступы петли с боковыми выступами на панели управления HPC-FP и вставьте штифты в петли на контроллере. Затем подсоедините шлейф к новой панели и подайте питание на контроллер.

### TR Pro-C Kontrol Ünitenizi HPC-FP Kiti ile Yenileştirme

**! Önemli:** Wi-Fi sinyalinin güçlü olduğundan emin olun. İki veya üç dış sinyal gücü önerilir. Wi-Fi bağlantısı, HPC Kontrol Ünitesi üzerinde de test edilebilir (bir kablosuz ağı seçtiğinizde sinyal gücü gösterilir).

1. Kontrol ünitesi monte edilip tüm kablolar bağlanmadan transformatörü güç kaynağına takmayın.
2. Kabine ulaşmak için kontrol ünitesi ön panelini açın, şerit kabloyu yerinden çıkarın, Pro-C ön panelinin arkasındaki açma pimine basarak ön paneli yerinden çıkarın.
3. HPC-FP ön panelinin yan tarafındaki pime basın, pimleri kontrol ünitesi kabinine takın, şerit kabloyu yeni ön panele yeniden bağlayın ve kontrol ünitesine yeniden güç verin.

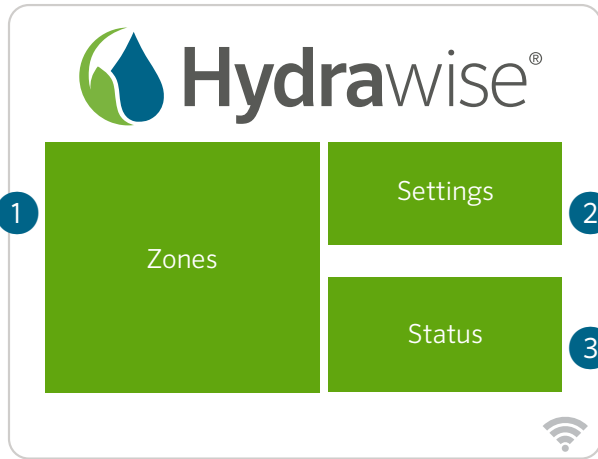

### Home Screen Navigation

- ① Touch to view all zones.
- ② Touch to change controller settings.
- ③ Touch to view controller status information.
- ④ Go to previous screen (changes not saved).
- ⑤ Go to Home screen (changes not saved).
- ⑥ GRAY items indicate status information.
- ⑦ GREEN items indicate settings which can be changed.

### DE Steuergerät Touchscreen Startbildschirm Navigation

- ① Tippen, um alle Zonen anzuzeigen.
- ② Tippen, um Steuergerät-Einstellungen zu ändern.
- ③ Tippen, um Statusinformationen des Steuergeräts aufzurufen.
- ④ Zum vorherigen Bildschirm wechseln (Änderungen werden nicht gespeichert).
- ⑤ Zum Startbildschirm wechseln (Änderungen werden nicht gespeichert).
- ⑥ GRAUE Felder zeigen Statusinformationen an.
- ⑦ GRÜNE Felder zeigen Einstellungen an, die geändert werden können.

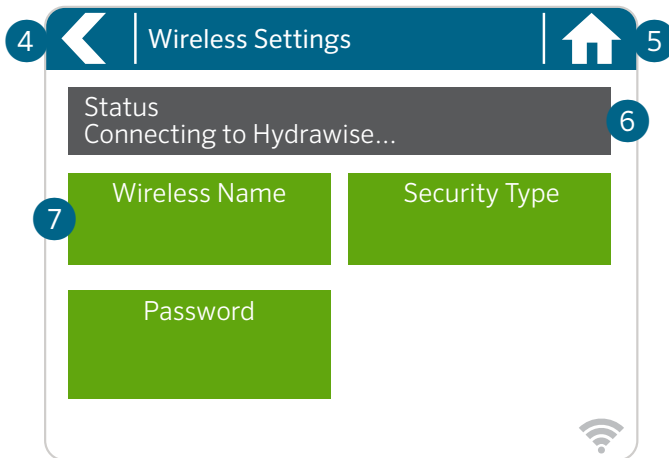

### **ES Pantalla Táctil del Programador Navegación de la Pantalla de Inicio**

- ① Pulse para ver todas las zonas.
- ② Pulse para cambiar los ajustes del programador.
- ③ Pulse para ver la información del estado del programador.
- ④ Ir a la pantalla previa (no se guardarán los cambios).
- ⑤ Ir a la pantalla de Inicio (no se guardarán los cambios).
- ⑥ Los elementos color GRIS indican la información del estado.
- ⑦ Los elementos color VERDE indican los ajustes que pueden cambiarse.

### **FR Écran tactile du programmeur Navigation sur l'écran d'accueil**

- ① Appuyez pour afficher toutes les zones.
- ② Appuyez pour modifier les paramètres du programmeur.
- ③ Appuyez pour consulter des informations sur l'état du programmeur.
- ④ Aller à l'écran précédent (les modifications ne sont pas enregistrées).
- ⑤ Aller à l'écran d'accueil (les modifications ne sont pas enregistrées).
- ⑥ Les éléments en GRIS indiquent des informations sur l'état.
- ⑦ Les éléments en VERT indiquent des paramètres pouvant être modifiés.

### **IT Programmatore touchscreen Navigazione nella schermata Home**

- ① Toccare per visualizzare tutte le zone.
- ② Toccare per modificare le impostazioni del programmatore.
- ③ Toccare per visualizzare le informazioni sullo stato del programmatore.
- ④ Passare alla schermata precedente (modifiche non salvate).
- ⑤ Passare alla schermata Home (modifiche non salvate).
- ⑥ Gli elementi in GRIGIO indicano le informazioni sullo stato.
- ⑦ Gli elementi in VERDE indicano le impostazioni che possono essere modificate.

### **PT Tela sensível ao toque do controlador Navegação na tela inicial**

- ① Toque para visualizar todos os setores.
- ② Toque para alterar as configurações do controlador.
- ③ Toque para ver as informações de status do controlador.
- ④ Vá para a tela anterior (alterações não salvas).
- ⑤ Vá para a tela inicial (alterações não salvas).
- ⑥ Itens em CINZA indicam as informações de status.
- ⑦ Itens em VERDE indicam as configurações que podem ser alteradas.

**RU Навигация по главному экрану контроллера с сенсорным дисплеем**

- ① Просмотреть все зоны.
- ② Изменить настройки контроллера.
- ③ Просмотреть состояние контроллера.
- ④ Перейти к предыдущему экрану (без сохранения изменений).
- ⑤ Перейти на главный экран (без сохранения изменений).
- ⑥ СЕРЫМ цветом выделена информация о состоянии.
- ⑦ ЗЕЛЕНЫМ цветом выделены настройки, которые можно изменить.

**TR Kontrol Ünitesinin Dokunmatik Ekranıyla Ana Ekranda Gezinme**

- ① Tüm bölgeleri görüntülemek için dokunun.
- ② Kontrol ünitesi ayarlarını değiştirmek için dokunun.
- ③ Kontrol ünitesi durum bilgilerini görüntülemek için dokunun.
- ④ Önceki ekrana gidin (değişiklikler kaydedilmez).
- ⑤ Ana ekrana gidin (değişiklikler kaydedilmez).
- ⑥ GRİ öğeler durum bilgilerini belirtir.
- ⑦ YEŞİL öğeler değiştirilebilecek ayarları belirtir.

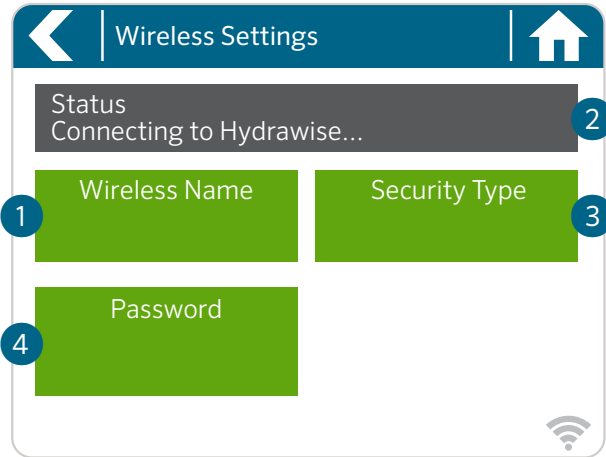



### Using the Connection Wizard

From the Home screen, touch the **Settings** button and then the **Wireless** button.



Select your wireless network from the list shown on the controller display and press the **Confirm** button on the screen. Enter your wireless password and press the **OK** button on the keyboard.



#### Important:

If your network is not listed, check that the unit is within wireless range. Make sure you press the **OK** button after you've entered your password. Pressing the **Home**  or **Back**  buttons will not save your changes.



- ① Touch to change the wireless access point.
- ② View wireless connection status.
- ③ Touch to change the wireless security type.
- ④ Touch to change the wireless password.

When connecting to your wireless network, the **Wi-Fi**  icon at the bottom right of the controller screen will flash. Connecting takes about 30 seconds. When successfully connected, the **Wi-Fi**  icon will remain solid.



#### DE Verbindungsassistenten verwenden

Tippen Sie auf dem Startbildschirm auf **Settings** und anschließend auf **Wireless**.

Wählen Sie Ihr Drahtlosnetzwerk aus der Liste im Display des Steuergeräts und tippen auf **Confirm** (Bestätigen). Geben Sie Ihr Kennwort ein und tippen auf **OK** auf dem Tastenfeld.

**! Wichtig:** Sollte Ihr Netzwerk nicht in der Liste aufgeführt sein, überprüfen Sie, ob sich das Gerät innerhalb der Netz-Reichweite befindet. Denken Sie daran, **OK** zu tippen, nachdem Sie Ihr Kennwort eingegeben haben. Durch Tippen auf **Home**  oder **Back**  werden Ihre Änderungen nicht gespeichert.

- ① Tippen, um WLAN-Zugangspunkt zu ändern.
- ② Status der WLAN-Verbindung anzeigen.
- ③ Tippen, um WLAN-Sicherheitstyp zu ändern.
- ④ Tippen, um WLAN-Kennwort zu ändern.



Wenn Sie sich mit Ihrem Drahtlosnetzwerk verbinden, blinkt das **Wi-Fi-Symbol**  unten rechts im Display des Steuergeräts auf. Der Verbindungsaufbau dauert ca. 30 Sekunden. Ist die Verbindung erfolgreich hergestellt, hört das **Wi-Fi-Symbol**  auf zu blinken und leuchtet konstant.





## ES Uso del Asistente de Conexión

En la pantalla de Inicio, pulse el botón **Ajustes** y luego el botón **Inalámbrico**.

Seleccione su red inalámbrica en la lista mostrada en la pantalla del programador y pulse el botón **Confirmar** en la pantalla. Introduzca la contraseña de su red inalámbrica y pulse el botón **OK** en el teclado.

**! Importante:** Si su red no aparece en la lista, compruebe que la unidad está dentro del alcance inalámbrico. Asegúrese de pulsar el botón **OK** después de haber introducido su contraseña. Si pulsa los botones **Inicio**  o **Atrás**  no se guardarán los cambios.



- ① Pulse para cambiar el punto de acceso inalámbrico.
- ② Ver estado de conexión inalámbrica.
- ③ Pulse para cambiar el tipo de seguridad inalámbrica.
- ④ Pulse para cambiar la contraseña inalámbrica.

Al conectarse a su red inalámbrica, el icono **Wi-Fi**  en la parte inferior derecha del programador parpadeará. La conexión tarda aproximadamente 30 segundos, y cuando se conecte, el icono **WiFi**  permanecerá fijo.



## FR Utilisation de l'assistant de connexion

Sur l'écran d'accueil, appuyez sur le bouton **Paramètres**, puis sur le bouton **Sans fil**.

Sélectionnez votre réseau sans fil dans la liste qui s'affiche sur l'écran du programmeur et appuyez sur le bouton **Confirmer** de l'écran. Saisissez votre mot de passe sans fil et appuyez sur le bouton **OK** d clavier.

**! Important :** Si votre réseau n'est pas répertorié, assurez-vous que le programmeur est à portée du réseau sans fil. Assurez-vous d'appuyer sur le bouton **OK** une fois que vous avez saisi votre mot de passe. Appuyer sur le bouton **Accueil**  ou **Retour**  ne sauvegardera pas vos modifications.



- ① Touchez pour modifier le point d'accès sans fil.
- ② Affichez l'état de la connexion sans fil.
- ③ Touchez pour modifier le type de sécurité sans fil.
- ④ Touchez pour modifier le mot de passe sans fil.

Lors de la connexion à votre réseau sans fil, l'icône **Wi-Fi**  située dans le coin inférieur droit de l'écran du programmeur clignote. La connexion prend environ 30 secondes. Une fois la connexion **Wi-Fi**  établie, l'icône cesse de clignoter.

### IT Utilizzo della connessione guidata

Nella schermata Home, toccare il pulsante **Impostazioni** e poi il pulsante **Wireless**.

Selezionare la rete wireless dall'elenco visualizzato sul display del programmatore e premere il pulsante **Conferma** sullo schermo. Inserire la password della rete wireless e premere il pulsante **OK** sulla tastiera.

**! Importante:** Se la rete non è presente nell'elenco, verificare che l'unità si trovi nel raggio d'azione della copertura wireless. Assicurarsi di premere il pulsante **OK** dopo aver inserito la password. Premendo i pulsanti **Home**  o **Indietro**  non verranno salvate le modifiche.



- ① Toccare per modificare il punto di accesso wireless.
- ② Visualizzare lo stato della connessione wireless.
- ③ Toccare per modificare il tipo di sicurezza wireless.
- ④ Toccare per modificare la password wireless.

Quando ci si connette alla rete wireless, l'icona del **Wi-Fi**, , situata in basso a destra dello schermo del programmatore, lampeggerà. La connessione richiede circa 30 secondi. Una volta connesso correttamente, il **Wi-Fi**  risulterà fissa.



### PT Usando o Assistente de Conexão

Na tela inicial, toque no botão **Configurações** e, em seguida, no botão **Sem fio**.

Selecione sua rede sem fio na lista na tela do controlador e pressione o botão **Confirmar** no visor. Introduza a senha sem fio e pressione o botão **OK** no teclado.

**! Importante:** Se a sua rede não estiver listada, verifique se a unidade está dentro do alcance sem fio. Certifique-se de pressionar o botão **OK** depois de inserir sua senha. Pressionar os botões **Início**  ou **Voltar**  não salvará suas alterações.



- ① Toque para alterar o ponto de acesso sem fio.
- ② Veja o status da conexão sem fio.
- ③ Toque para alterar o tipo de segurança sem fio.
- ④ Toque para alterar a senha sem fio.

Ao se conectar à sua rede sem fio, o ícone de **Wi-Fi**  na parte inferior direita do visor do controlador piscará. A conexão leva cerca de 30 segundos. Quando conectado com sucesso, o **Wi-Fi**  permanecerá constante.



### RU Работа с мастером подключения

На главном экране нажмите кнопку **Settings** («Настройки»), а затем — **Wireless** («Беспроводная сеть»).

Выберите свою беспроводную сеть из списка на дисплее контроллера и нажмите экранную кнопку **Confirm** («Подтвердить»). Введите пароль для подключения к сети и нажмите кнопку **OK** на клавиатуре.

**! Важно:** Если вашей сети нет в списке, убедитесь, что контроллер находится в зоне ее действия. Также обязательно нажмите кнопку **OK** после ввода пароля. Если на этом этапе вы нажмете кнопку **Home**  («Главная») или **Back** , изменения не сохранятся.



- ① Изменить настройки беспроводной точки доступа.
- ② Просмотреть состояние беспроводного подключения.
- ③ Изменить тип защиты беспроводной сети.
- ④ Изменить пароль от Wi-Fi.

Пока контроллер пытается подключиться к беспроводной сети, значок **Wi-Fi**  в его нижней правой части будет мигать. Процесс подключения длится около 30 секунд. Если контроллер установит соединение, значок **Wi-Fi**  будет гореть постоянно.



### TR Bağlantı Sihirbazını Kullanma

Ana ekranda **Settings (Ayarlar)** düğmesine ve ardından **Wireless (Kablosuz)** düğmesine dokununuz.

Kontrol ünitesinin ekranında gösterilen listeden kablosuz ağıınızı seçin ve ekrandaki **Confirm (Onayla)** düğmesine basın. Kablosuz bağlantı şifrenizi girin ve klavyedeki **OK (Tamam)** düğmesine basın.

**! Önemli:** Ağınız listede yoksa ünitenin kablosuz ağ kapsama alanında olup olmadığını kontrol edin. Şifreyi girdikten sonra **OK (Tamam)** düğmesine bastığınızdan emin olun. **Home (Ana Ekran)**  veya **Back (Geri)**  düğmelerine basarsanız değişiklikleriniz kaydedilmez.

- ① Kablosuz erişim noktasını değiştirmek için dokununuz.
- ② Kablosuz bağlantı durumunu görüntüleyin.
- ③ Kablosuz bağlantı güvenlik türünü değiştirmek için dokununuz.
- ④ Kablosuz bağlantı şifresini değiştirmek için dokununuz.

Kablosuz ağıınıza bağlanırken kontrol ünitesi ekranının sağ alt kısmındaki **Wi-Fi**  simgesi yanıp sönecektir. Bağlantı kurulması yaklaşık 30 saniye sürer. Başarıyla bağlantı kurulduğunda **Wi-Fi**  simgesi sabit kalacaktır.

### U.S. FCC Statement

This equipment has been tested and found to comply with the limits for a Class B digital device, pursuant to Part 15 of the FCC Rules. These limits are designed to provide reasonable protection against harmful interference in a residential installation. This equipment generates, uses and can radiate radio frequency energy, and if not installed and used in accordance with the instructions, may cause harmful interference to radio communications. However, there is no guarantee that interference will not occur in a particular installation. If this equipment does cause harmful interference to radio or television reception, which can be determined by turning the equipment off and on, the user is encouraged to try to correct the interference by one or more of the following measures:

- Reorient or relocate the receiving antenna.
- Increase the separation between the equipment and receiver.
- Connect the equipment into an outlet on a circuit different from where the receiver is connected.
- Consult the dealer or an experienced radio/TV technician for help.

To satisfy FCC RF Exposure requirements for mobile and base station transmission devices, a separation distance of 8" (20 cm) or more should be maintained between the antenna of this device and persons during operation. To ensure compliance, operation at closer than this distance is not recommended. The antenna(s) used for this transmitter must not be co-located or operating in conjunction with any other antenna or transmitter.

### Innovation, Science and Economic Development Canada (ISED) Compliance Notice

This device contains licence-exempt transmitter(s)/receiver(s) that comply with Innovation, Science and Economic Development Canada's licence-exempt RSS(s). Operation is subject to the following two conditions:

1. This device may not cause interference.
2. This device must accept any interference, including interference that may cause undesired operation of the device.

### Déclaration d'Industrie Canada

Le présent appareil est conforme aux CNR d'Innovation, Sciences et Développement économique Canada applicables aux appareils radio exempts de licence. L'exploitation est autorisée aux deux conditions suivantes:

1. L'appareil ne doit pas produire de brouillage.
2. L'utilisateur de l'appareil doit accepter tout brouillage radioélectrique subi, même si le brouillage est susceptible d'en compromettre le fonctionnement.



### Certificate of Conformity to European Directives

Hereby, Hunter Industries declares that the radio equipment type models HC-601i-E, HC-1201i-E, HPC-401-E, PHC-601-E, PHC-601i-E, PHC-1201-E, PHC-1201i-E, PHC-2401-E, PHC-2401i-E are in compliance with Directive 2014/53/EU. The full text of the EU declaration of conformity is available at the following Internet address: [subsidiary.hunterindustries.com/compliance/](https://subsidiary.hunterindustries.com/compliance/)

- Frequency Band of Operation (MHz): 2,412 to 2,472
- Maximum Transmit Power (dBm): 18.5

**DE** Hiermit erklärt Hunter Industries, dass der Funkanlagentyp HC-601i-E, HC-1201i-E, HPC-401-E, PHC-601-E, PHC-601i-E, PHC-1201-E, PHC-1201i-E, PHC-2401-E, PHC-2401i-E der Richtlinie 2014/53/EU entspricht. Der vollständige Text der EU-Konformitätserklärung ist unter der folgenden Internetadresse verfügbar: **[subsite.hunterindustries.com/compliance/](http://subsite.hunterindustries.com/compliance/)**

- Frequenzband (MHz): 2,412 to 2,472
- Max. Sendeleistung (dBm): 18.5

**ES** Por el presente documento, Hunter Industries declara que los modelos de equipos de tipo radio HC-601i-E, HC-1201i-E, HPC-400-E, PHC-601-E, PHC-601i-E, PHC-1201-E, PHC-1201i-E, PHC-2401-E y PHC-2401i-E cumplen con la Directiva 2014/53/UE. El texto completo de la declaración de conformidad de la UE está disponible en la siguiente dirección de Internet:

**[subsite.hunterindustries.com/compliance/](http://subsite.hunterindustries.com/compliance/)**

- Banda de frecuencia de funcionamiento (MHz): 2,412 a 2,472
- Potencia máxima de transmisión (dBm): 18,5

**FR** Hunter Industries déclare par la présente que les modèles d'équipement radio HC-601i-E, HC-1201i-E, HPC-400-E, PHC-601-E, PHC-601i-E, PHC-1201-E, PHC-1201i-E, PHC-2401-E, PHC-2401i-E sont conformes à la directive 2014/53/UE. Le texte intégral de la déclaration de conformité de l'UE est disponible à l'adresse Internet suivante :

**[subsite.hunterindustries.com/compliance/](http://subsite.hunterindustries.com/compliance/)**

- Bande de fréquences de fonctionnement (MHz) : 2 412 à 2 472
- Puissance d'émission maximale (dBm) : 18,5

**IT** Con la presente, Hunter Industries dichiara che il tipo di apparecchiatura radio dei modelli HC-601i-E, HC-1201i-E, HPC-400-E, PHC-601-E, PHC-601i-E, PHC-1201-E, PHC-1201i-E, PHC-2401-E e PHC-2401i-E sono conformi alla Direttiva 2014/53/UE. Il testo completo della dichiarazione di conformità UE è disponibile all'indirizzo:

**[subsite.hunterindustries.com/compliance/](http://subsite.hunterindustries.com/compliance/)**

- Banda di frequenza di funzionamento (MHz): da 2412 a 2472
- Potenza massima di trasmissione (dBm): 18,5

**PT** A Hunter Industries declara que os modelos do tipo de equipamento de rádio: HC-601i-E, HC-1201i-E, HPC-400-E, PHC-601-E, PHC-601i-E, PHC-1201-E, PHC-1201i-E, PHC-2401-E, PHC-2401i-E estão em conformidade com a Diretiva 2014/53/UE. O texto completo da declaração de conformidade da UE está disponível no seguinte endereço da internet:

**[subsite.hunterindustries.com/compliance/](http://subsite.hunterindustries.com/compliance/)**

- Faixa de operação de frequência (MHz): 2.412 a 2.472
- Potência máxima de transmissão (dBm): 18,5

**TR** Hunter Industries, HC-601i-E, HC-1201i-E, HPC-400-E, PHC-601-E, PHC-601i-E, PHC-1201-E, PHC-1201i-E, PHC-2401-E, PHC-2401i-E telsiz ekipmanı modellerinin 2014/53/EU sayılı Yönerge ile uyumlu olduğunu beyan eder. AB uygunluk beyanının tam metnine aşağıdaki internet adresinden ulaşılabilir:

**[subsite.hunterindustries.com/compliance/](http://subsite.hunterindustries.com/compliance/)**

- Çalışma Frekans Bandı (MHz): 2.412 - 2.472
- Azami İletim Gücü (dBm): 18,5

Notes

---



---



---



---



---



---



---



---



---



---



---



---



---



---



---



---



---



---



---



---



---



---



---



---



---

Helping our customers succeed is what drives us. While our passion for innovation and engineering is built into everything we do, it is our commitment to exceptional support that we hope will keep you in the Hunter family of customers for years to come.



**Gregory R. Hunter, CEO of Hunter Industries**



**Denise Mullikin, President, Landscape Irrigation and Outdoor Lighting**

---

**HUNTER INDUSTRIES** | *Built on Innovation*<sup>®</sup>  
1940 Diamond Street, San Marcos, CA 92078 USA  
hunterindustries.com

© 2024 Hunter Industries Inc. Hunter, the Hunter logo, and other marks are trademarks of Hunter Industries Inc., registered in the U.S. and certain other countries. ♻️ Please recycle.